

BLITZ SIDE BRACKET ROUND LEDGE

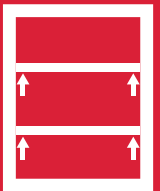

SHELF
SUPPORTS



SYMBOLS AND FINISHES LEGEND

SYMBOLS

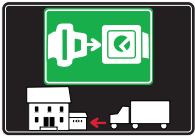

= SHELF SAFELY LOCKED DURING TRANSPORTATION AND AT HOME.



= ANTI-TURNOVER LOCKING SYSTEM



= NORMS / PATENTS



= PHILLIPS / POZIDRIV



= NEWTON



= PART.NO



= HEXAGONAL SOCKET



= FRICTION



= PCS. PER PACKAGE



= BLADE SLOT



= AUTOMATIC



= CAPACITY LOADING



= COUNTERSUNK HEAD



= WOOD / GLASS THICKNESS



= PAN HEAD



= STANDARD HINGE



= HOLE DIAMETER



= FLANGE HEAD



= KIMANA HINGE



= DIAMETER



= FLAT HEAD



= FLAP HINGE



= LENGTH



= TRILOBULAR SCREW



= WITH SPRING



= HEIGHT



= SELF-TAPPING SCREW



= WITHOUT SPRING



= RIGHT VERSION



= EURO THREAD



= REVERSED SPRING



= LEFT VERSION



= METRIC THREAD



= PRE-INSERTED SCREW



= FOR ROUND TUBE



= PCS. PER PAD



= PRE-INSERTED SCREW AND SPREADING BUSH



= FOR OVAL TUBE



= CUT ON REQUEST



= WITH BUFFER



= SELF ADHESIVE



= WITH MAGNET



= WITH FLANGE

MATERIALS

ZA = Zinc Alloy	ST = Steel	HSS = High Speed Steel	BR = Brass	ABS = Acrylonitrile Butadiene Styrene
ZAnk = Nickel-plated Zinc Alloy	STzk = Zinc-plated Steel	AL = Aluminium	WD = Wood	EVA = Ethylene Vinyl Acetate

EP = **ENGINEERING PLASTIC**

+ **EP** = other engineering plastic available on request

SR = **SOFT RUBBER**

+ **SR** = other soft rubber available on request

EPn = Natural Engineering Plastic	EPc = Clear Engineering Plastic	SRn = Natural Soft Rubber
EPw = White Engineering Plastic	EPg = Grey Engineering Plastic	SRw = White Soft Rubber
EPwg = Water Green Engineering Plastic		SRb = Black Soft Rubber

FINISHES

+  = OTHER FINISHES AVAILABLE ON REQUEST

PART. NO	FINISHES	PART. NO	FINISHES	PART. NO	FINISHES
AA	Natural	JB	Bright Aluminium	PZ	Beech
AB	White	JC	Aluminium - Chrome	QA	Maple
AC	Opal White	JD	Matt Aluminium	QB	Walnut
AE	White 9010	JE	Satin-finished Aluminium	WA	Bronzed
AK	Champagne	JF	Aluminium - Brass	WI	Burnished
AL	Ivory	JG	Aluminium 5	XD	Satin-finished Steel
EA	Black	JL	Aluminium PE 11	YA	Nickel-plated
EB	Glossy Black	JM	Aluminium RAL 9006	YB	Bright Nickel-plated
EC	Matt Black	KA	Chrome	YC	Matt Nickel-plated
GR	Raw	KB	Bright Chrome	YD	Satin-finished Nickel-plated
HA	Brass-Plated	KC	Matt Chrome	ZA	Zinc alloy
HH	Tropicalized	MA	Brown	ZN	Zinc-plated
HL	Raw Brass	MB	Light Brown 1	ZQ	Bright Gold
IA	Grey	NN	Metallic Beige	ZY	Titanium
IB	Metallic Grey	NO	Beige	ZZ	Clear
IF	Middle Grey	OA	Oak	00	Insignificant finish
IJ	Light Grey	OZ	Ash		
IL	Grey 20	PA	Light Ash		
JA	Aluminium	PY	Cherry		



BLITZ FOR 30 mm SHELF SIDE BRACKET ROUND LEDGE

BLITZ is the shelf support slotted into the shelf by making edge borings. If required the side bracket ledge can flush with the underside of the shelf by making face borings. The sleeve expands by inserting the provided pin, which improves the structural fastening of the shelf to the sides of the furniture. The shelf has to be pushed downwards onto the side bracket, which can be screwed into any position required. The side brackets slot into the socket of the shelf supports and a first click locks the shelf in position. After turning the cam pin placed inside the shelf support 180° anticlockwise, the shelf is really locked.

BLITZ ROUND LEDGE is available for 30 and 39 mm shelf thickness.

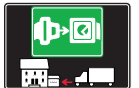

30 mm min.

INSTALLATION AND ASSEMBLING

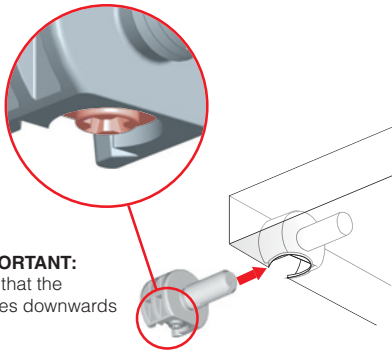

VERY IMPORTANT:
Make sure that the mini fix faces downwards

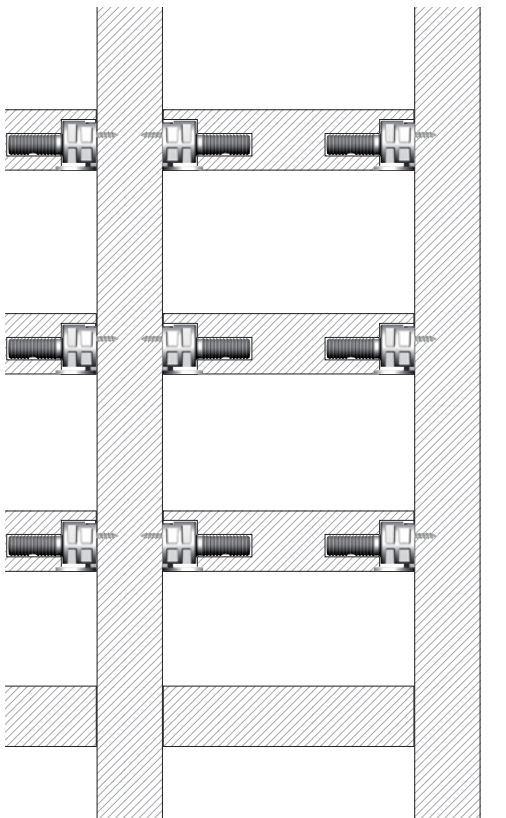
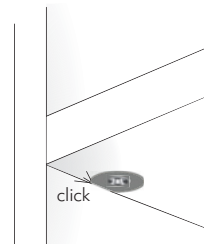
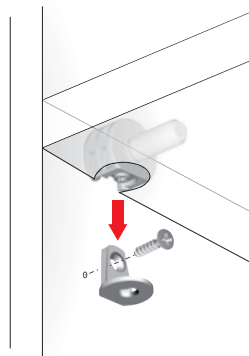

STRUCTURAL FASTENING WITH CROSS PZ2 SCREWDRIVER:

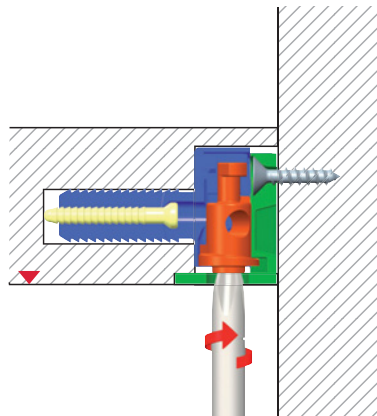

90° turning.

The sleeve expands by inserting the pre-mounted pin.

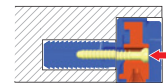

Assembling with alternative fixing options.

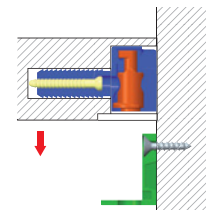

Assembling with pre-inserted spreading bush and screw to avoid hole damaging for shelf repositioning.

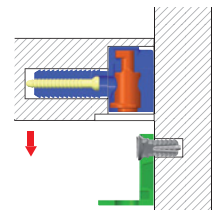

LOCKING DETAIL:

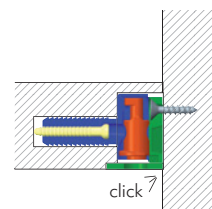

After turning the minifix.

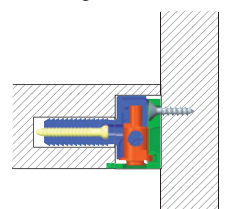



Also suitable for top and bottom panels when a back panel is used.



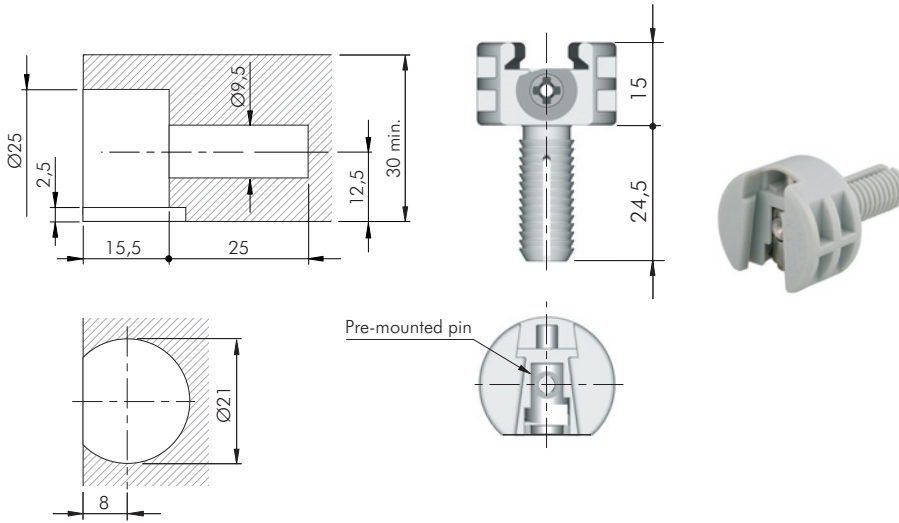

BLITZ  **30 mm**







 = PZ2

ZA EP ST  = 2500 pcs.

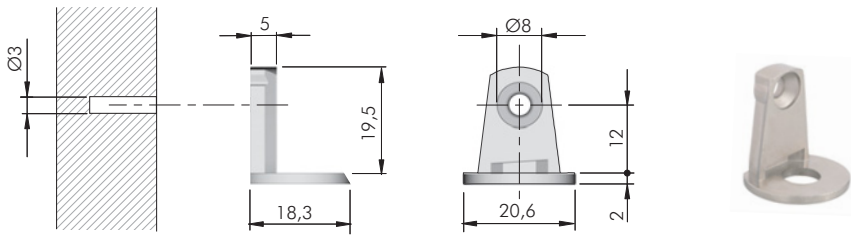

 123 

11201030EA



 = Ø 3 mm  + 

ZA  = 2500 pcs.

 123 

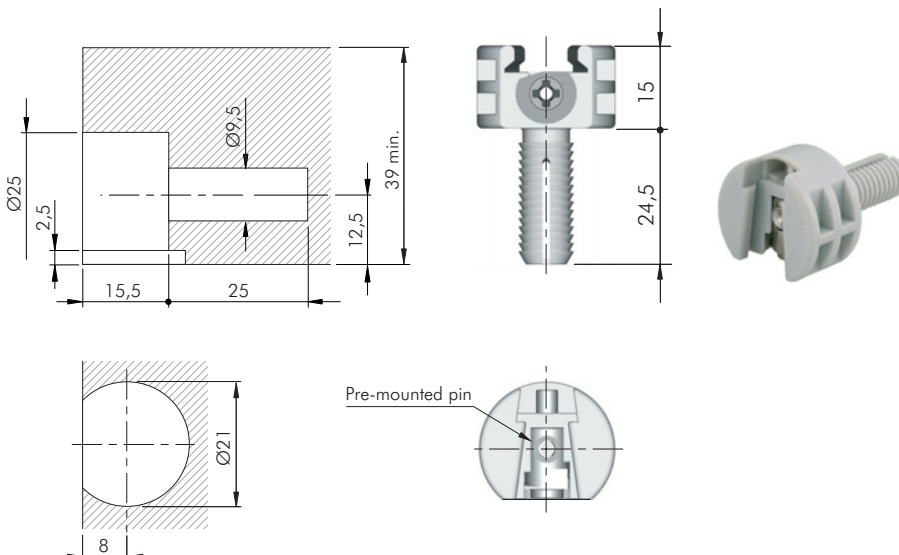

11205010YA

BLITZ  **39 mm**



 = PZ2

ZA EP ST  = 2500 pcs.

 123 

11201030EA

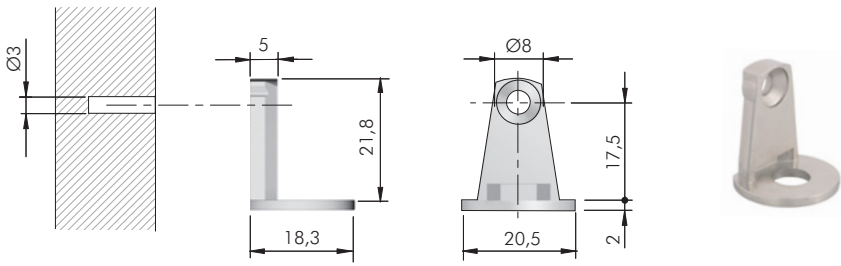

= Ø 3 mm +
 ZA = 2500 pcs.

 11206010YA

BLITZ ROUND LEDGE FIXING ACCESSORY

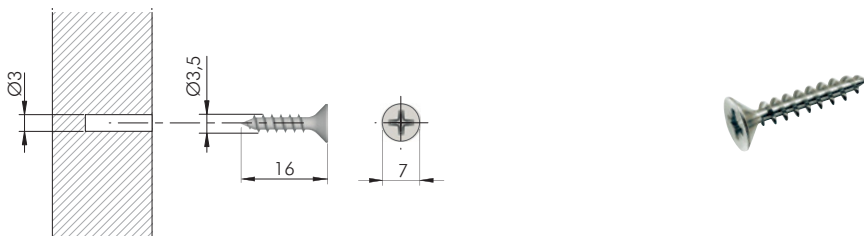

= Ø 3 mm
 = PZ2
 ST = 10.000 pcs.

 60101390ZN

DRILL BIT FOR BLITZ 30, 39 mm

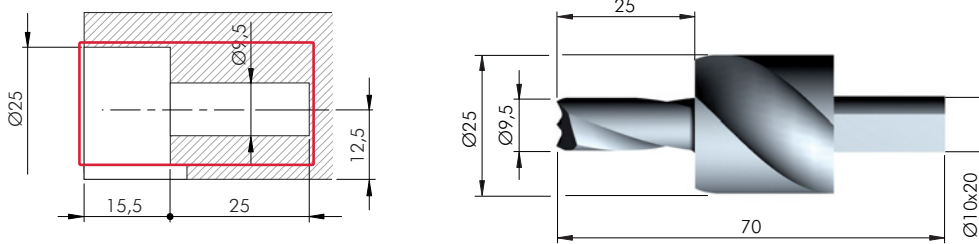

HSS = on request

 1125030000
 1125040000

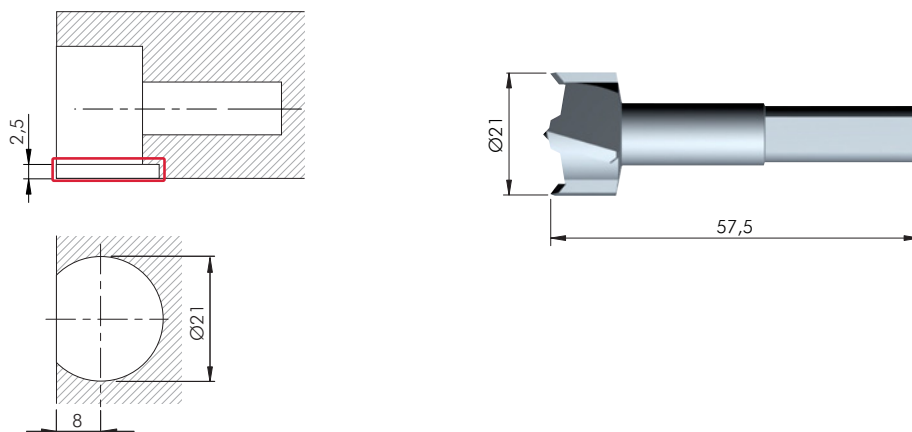

HSS = on request

 1125050000

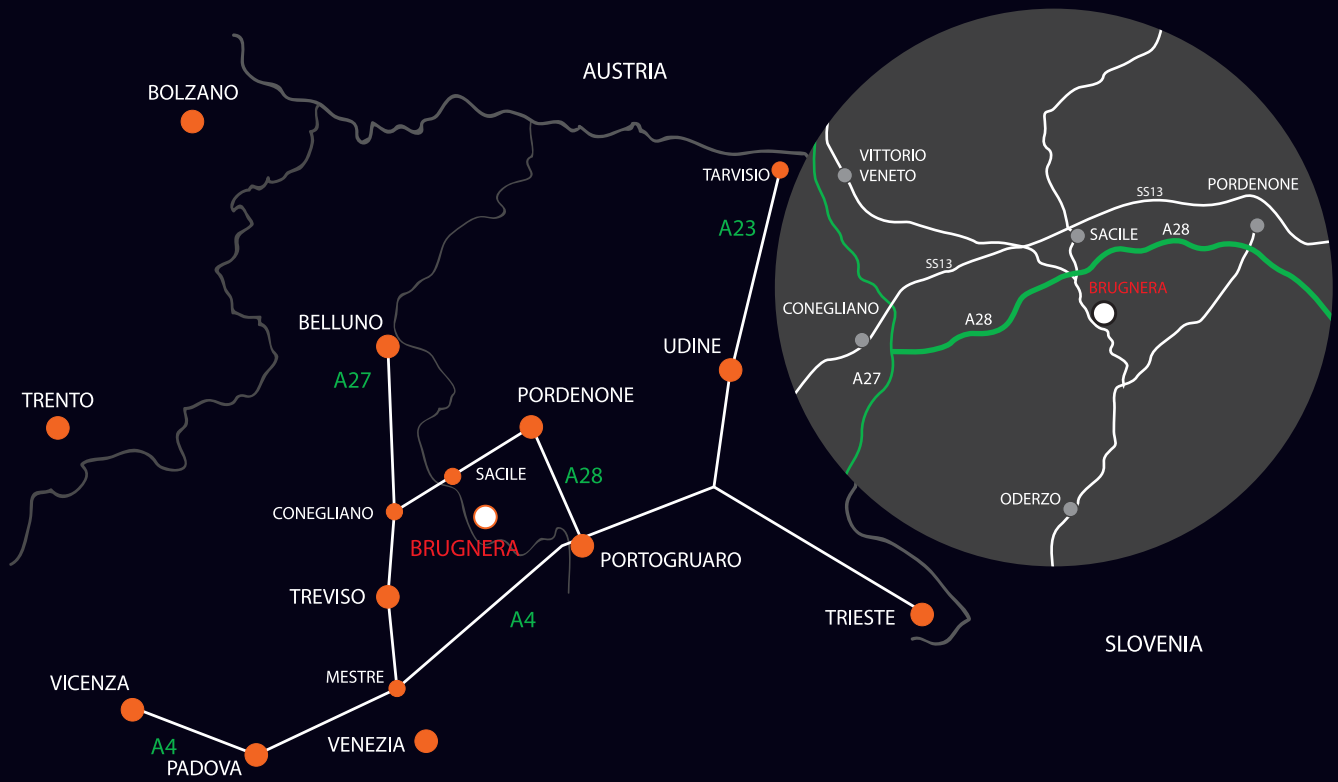

www.italianaferramenta.com