

**BOX FOR QUICK Ø 30**

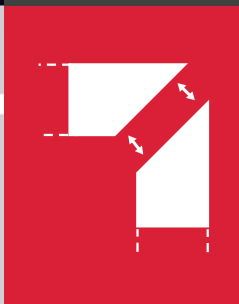

**WORKTOP  
CONNECTORS**



# SYMBOLS AND FINISHES LEGEND

## SYMBOLS

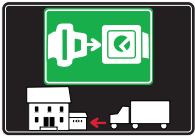

= SHELF SAFELY LOCKED DURING TRANSPORTATION AND AT HOME.



= ANTI-TURNOVER LOCKING SYSTEM



= NORMS / PATENTS



= PHILLIPS / POZIDRIV



= NEWTON



= PART.NO



= HEXAGONAL SOCKET



= FRICTION



= PCS. PER PACKAGE



= BLADE SLOT



= AUTOMATIC



= CAPACITY LOADING



= COUNTERSUNK HEAD



= WOOD / GLASS THICKNESS



= PAN HEAD



= STANDARD HINGE



= HOLE DIAMETER



= FLANGE HEAD



= KIMANA HINGE



= DIAMETER



= FLAT HEAD



= FLAP HINGE



= LENGTH



= TRILOBULAR SCREW



= WITH SPRING



= HEIGHT



= SELF-TAPPING SCREW



= WITHOUT SPRING



= RIGHT VERSION



= EURO THREAD



= REVERSED SPRING



= LEFT VERSION



= METRIC THREAD



= FOR ROUND TUBE



= PCS. PER PAD



= PRE-INSERTED SCREW AND SPREADING BUSH



= FOR OVAL TUBE



= CUT ON REQUEST



= WITH BUFFER



= WITH MAGNET



= WITH FLANGE

## MATERIALS

<b>ZA</b> = Zinc Alloy	<b>ST</b> = Steel	<b>HSS</b> = High Speed Steel	<b>BR</b> = Brass	<b>ABS</b> = Acrylonitrile Butadiene Styrene
<b>ZAnk</b> = Nickel-plated Zinc Alloy	<b>STzk</b> = Zinc-plated Steel	<b>AL</b> = Aluminium	<b>WD</b> = Wood	<b>EVA</b> = Ethylene Vinyl Acetate

**EP** = **ENGINEERING PLASTIC**

+ **EP** = other engineering plastic available on request

**SR** = **SOFT RUBBER**

+ **SR** = other soft rubber available on request

<b>EPn</b> = Natural Engineering Plastic	<b>EPc</b> = Clear Engineering Plastic	<b>SRn</b> = Natural Soft Rubber
<b>EPw</b> = White Engineering Plastic	<b>EPg</b> = Grey Engineering Plastic	<b>SRw</b> = White Soft Rubber
<b>EPwg</b> = Water Green Engineering Plastic		<b>SRb</b> = Black Soft Rubber

## FINISHES

+  = OTHER FINISHES AVAILABLE ON REQUEST

PART. NO	FINISHES	PART. NO	FINISHES	PART. NO	FINISHES
AA	Natural	JB	Bright Aluminium	PZ	Beech
AB	White	JC	Aluminium - Chrome	QA	Maple
AC	Opal White	JD	Matt Aluminium	QB	Walnut
AE	White 9010	JE	Satin-finished Aluminium	WA	Bronzed
AK	Champagne	JF	Aluminium - Brass	WI	Burnished
AL	Ivory	JG	Aluminium 5	XD	Satin-finished Steel
EA	Black	JL	Aluminium PE 11	YA	Nickel-plated
EB	Glossy Black	JM	Aluminium RAL 9006	YB	Bright Nickel-plated
EC	Matt Black	KA	Chrome	YC	Matt Nickel-plated
GR	Raw	KB	Bright Chrome	YD	Satin-finished Nickel-plated
HA	Brass-Plated	KC	Matt Chrome	ZA	Zinc alloy
HH	Tropicalized	MA	Brown	ZN	Zinc-plated
HL	Raw Brass	MB	Light Brown 1	ZQ	Bright Gold
IA	Grey	NN	Metallic Beige	ZY	Titanium
IB	Metallic Grey	NO	Beige	ZZ	Clear
IF	Middle Grey	OA	Oak	00	Insignificant finish
IJ	Light Grey	OZ	Ash		
IL	Grey 20	PA	Light Ash		
JA	Aluminium	PY	Cherry		

## BOX FOR QUICK Ø 30 AND COVER CAP

**BOX FOR QUICK Ø 30** has been conceived to easily join together honeycomb worktops, panels and free standing shelvings minimum 40 mm thick.

It consists of three parts:

- box for tightening dowel M8 x 50
- box for round cap to suit the dowel head.
- cover cap (to be used when needed/requested)

The installation is fast and simple as the two parts don't fall when placed in position.

Box for quick when in place becomes the housing for the quick (see the related page).

The fastening becomes easier by using an S6 mm allen wrench, or even better, a cordless driver-drill with S6 mm hexagonal bit.

The tightening is 6 mm.

Engineering plastic, steel and zinc alloy.



40 mm min.

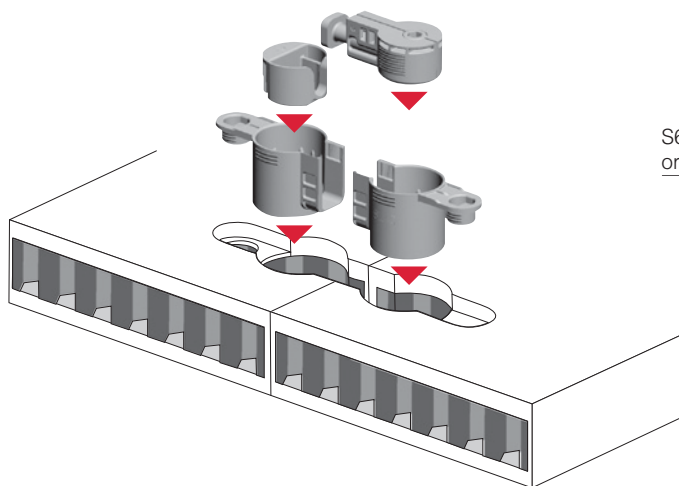

S6 mm allen wrench  
or cordless driver-drill

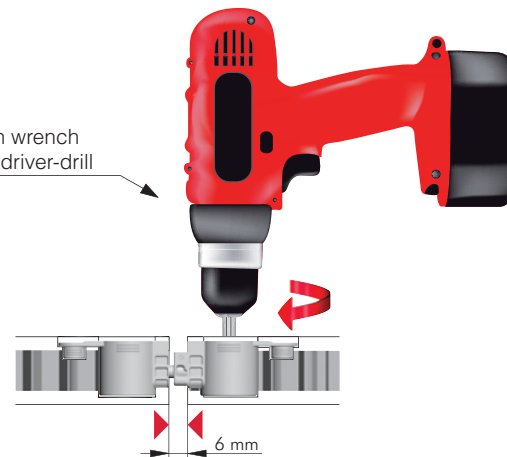

Captivating painted cover cap to be placed in position for connecting free standing shelvings together.

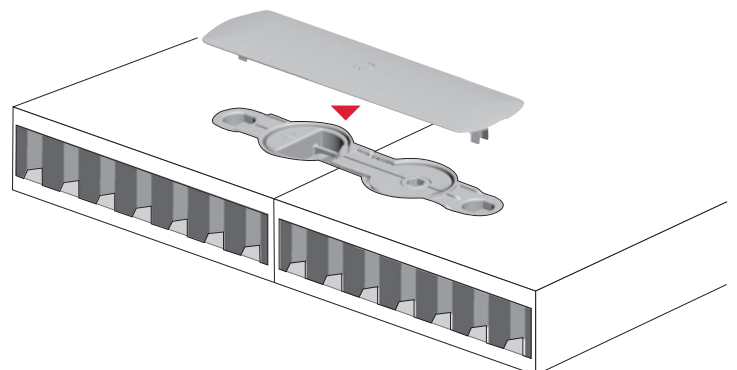
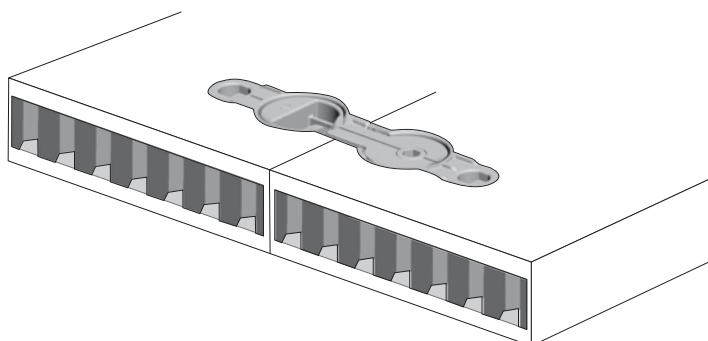

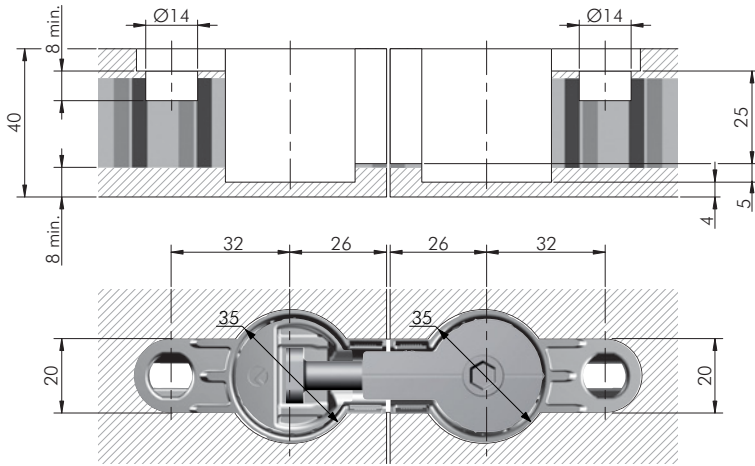

 = 40 mm

EP

 = 500 pcs.



2162201000

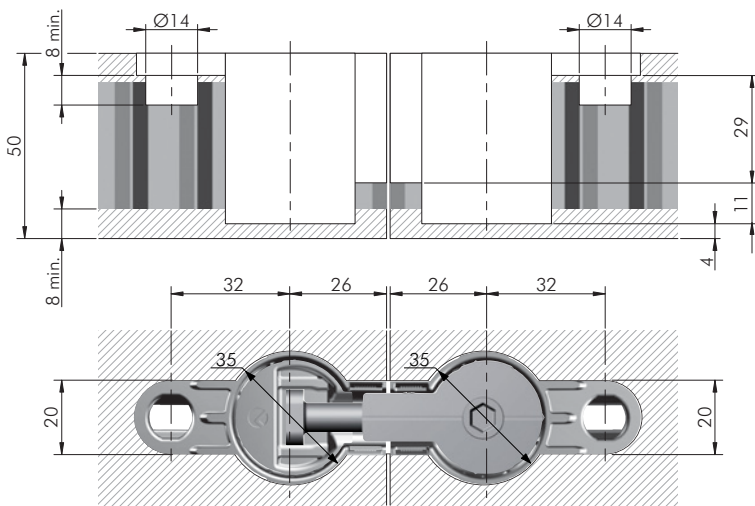

 = 50 mm

EP

 = 400 pcs.



2162203000

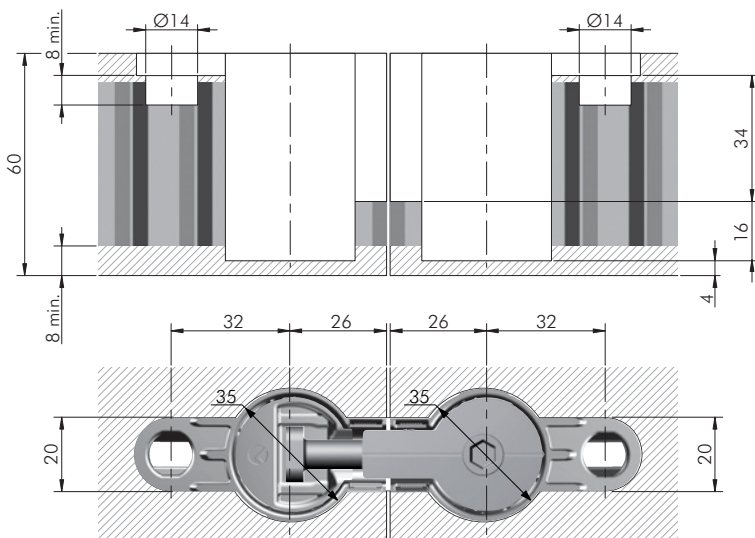

 = 60 mm

EP

 = 400 pcs.



2162205000

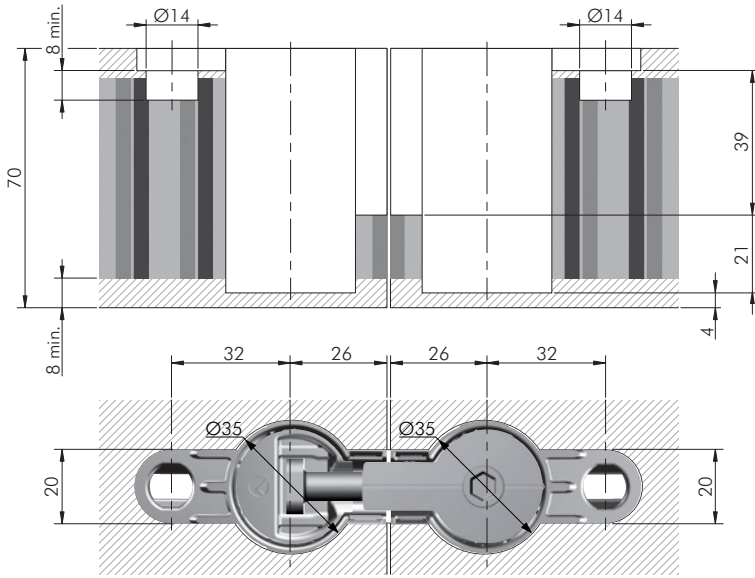

= 70 mm



= 100 pcs.



2162207000



## COVER CAP FOR BOX FOR QUICK Ø 30

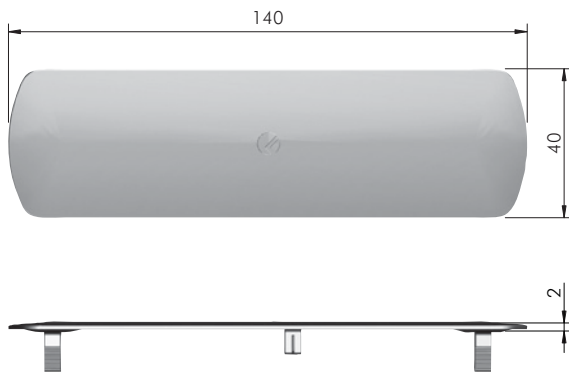

= on request



21622000JM

21622000KB



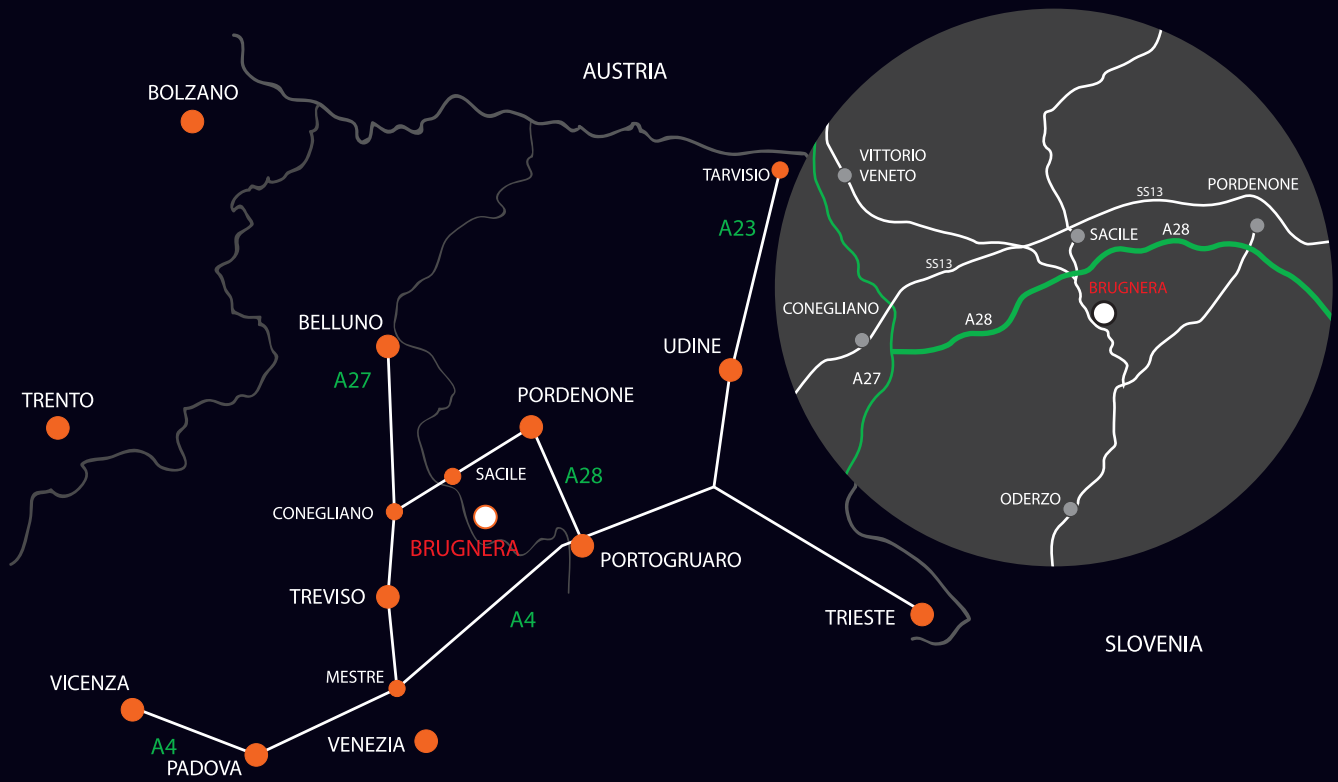

[www.italianaferramenta.com](http://www.italianaferramenta.com)