



**KLINE**

# K LINE

**K LINE** is an essential and functional solution of design that satisfies the most common requirements for the shelf supports.

**K LINE** has been developed with a highly captivating and elegant shape so that it can be used as a shelf support for both wood shelves and glass shelves, in the latter case simply by applying a bespoke layer of rubber.

A version of **K LINE** with a vertical pin of  $\varnothing 5$  mm has been also developed in order to lock the shelf horizontally.

In any case, all the versions of **K LINE** respect the European regulation UNI EN 14749/05

Zinc alloy  
Engineering plastic rubber



## ASSEMBLING K LINE

**1**

INSERT THE SHELF DIAGONALLY INTO THE CABINET

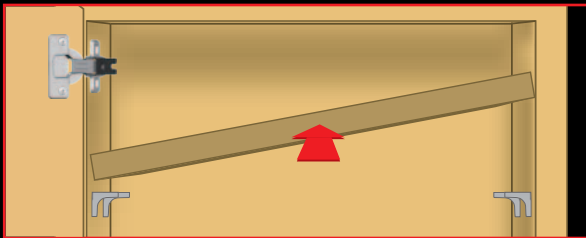

**2**

REST THE SHELF OVER THE K LINE SHELF SUPPORT

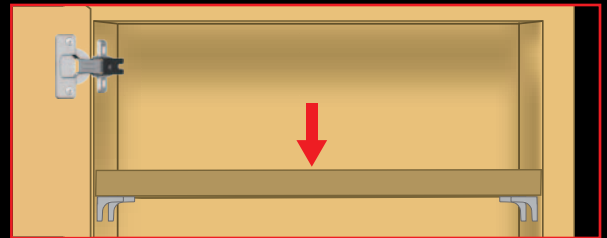

## ASSEMBLING K LINE WITH LOCKING PIN

**1**

INSERT THE SHELF DIAGONALLY INTO THE CABINET

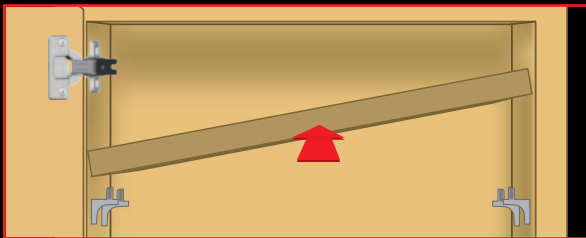

**2**

REST THE SHELF OVER THE K LINE SHELF SUPPORT

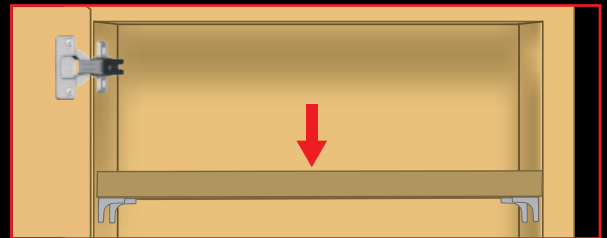

## ASSEMBLING K LINE GLASS SHELF SUPPORT

**1**

INSERT THE (GLASS) SHELF DIAGONALLY INTO THE CABINET

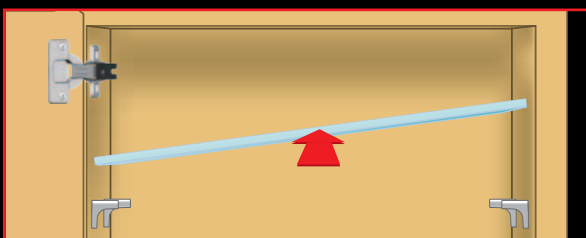

**2**

REST THE (GLASS) SHELF OVER THE K LINE GLASS SHELF SUPPORT

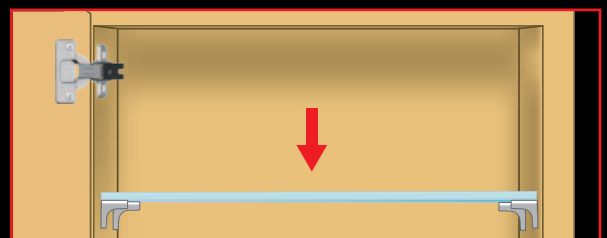

K LINE

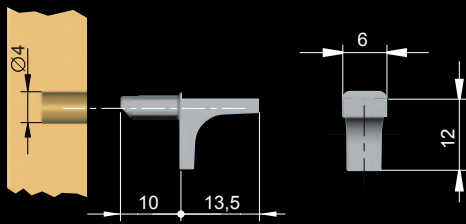

With Ø4mm pin.

Part. no	Finish
10208110YA	Nickel

Other finishes available on request

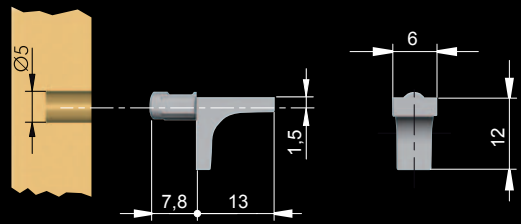

With Ø5mm pin.

Part. no	Finish
10208020YA	Nickel

Other finishes available on request

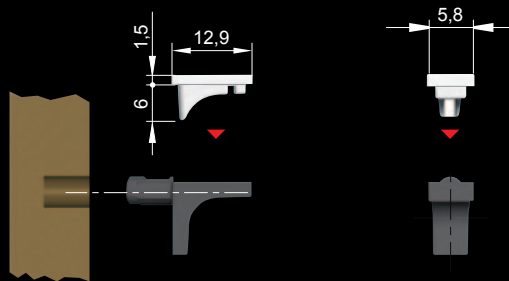

Clear rubber pad (supplied as separate part).

Part. no	Finish
10208060AA	Clear

K LINE WITH PIN TO LOCK THE SHELF HORIZONTALLY

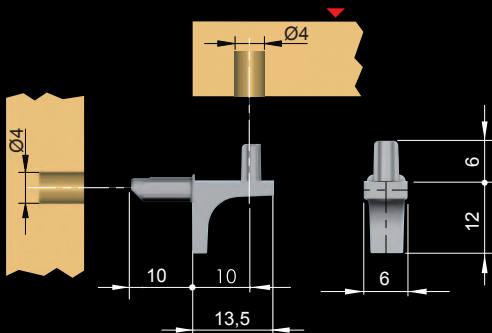

With Ø4mm pin and Ø4mm shelf-fixing lug.

Part. no	Finish
10208140YA	Nickel

Other finishes available on request

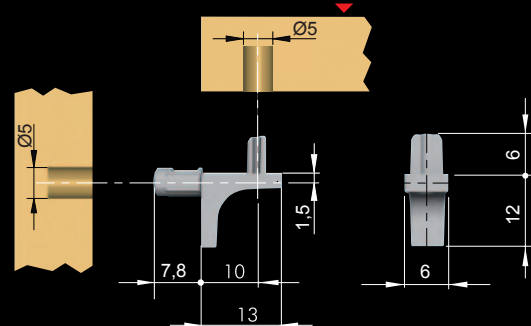

With Ø5mm pin and Ø5mm shelf-fixing lug.

Part. no	Finish
10208050YA	Nickel

Other finishes available on request

K LINE SHELF SUPPORT WITH CLEAR RUBBER PAD INSERTED FOR GLASS SHELVES

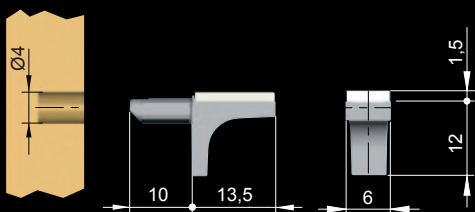

With Ø4mm pin.

Part. no	Plastic	Finish
10208130YA	Natural	Nickel

Other finishes available on request

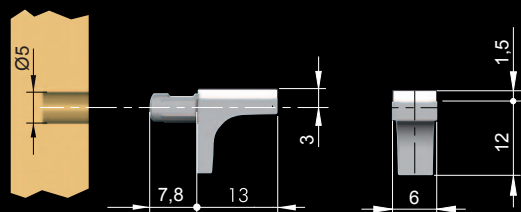

With Ø5mm pin .

Part. no	Plastic	Finish
10208030YA	Natural	Nickel

Other finishes available on request

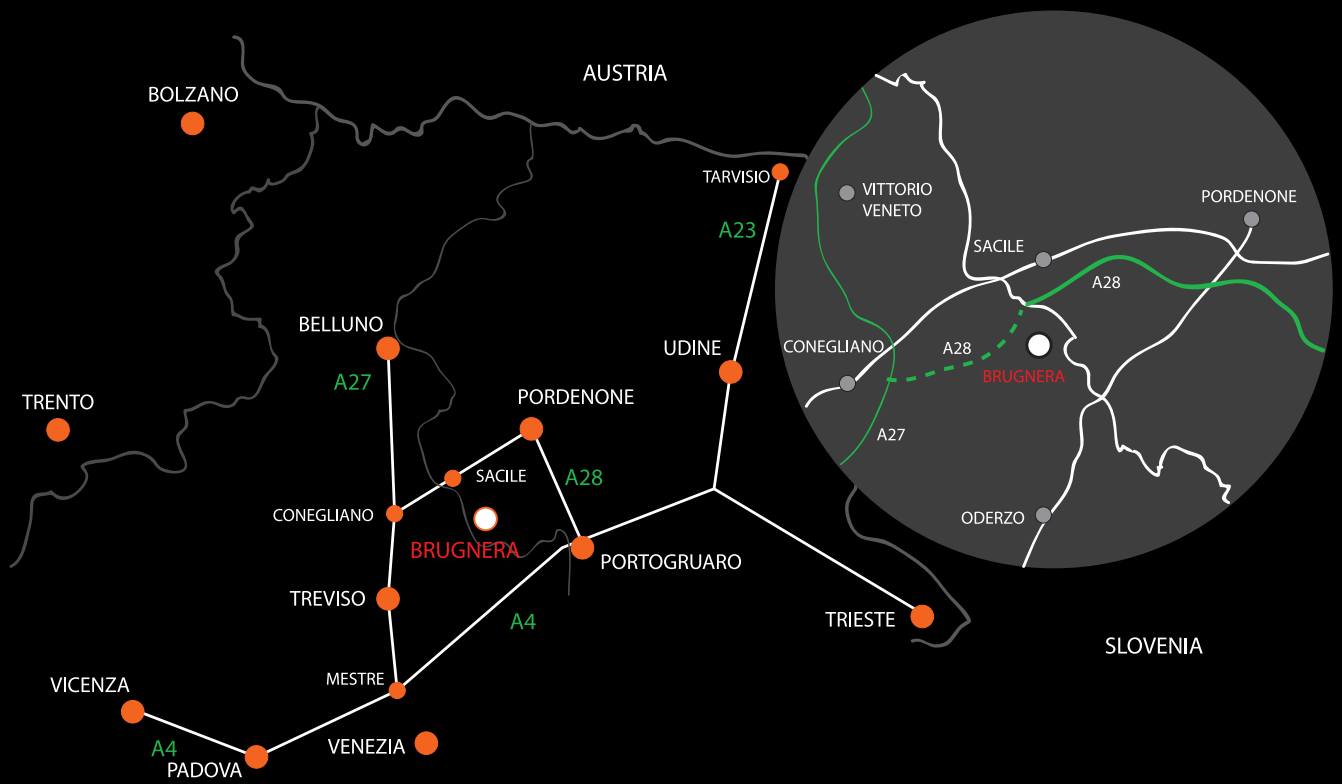

ITALIANA FERRAMENTA

via Taglio n° 87 I - 33070 Maron di Brugnera (PN) Tel. +39 0434 428211 Fax +39 0434 428242 [www.italianaferramenta.it](http://www.italianaferramenta.it) [info@italianaferramenta.it](mailto:info@italianaferramenta.it)