

TRIAD E MAXI

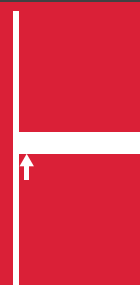

WOOD AND
GLASS
SHELVING
SYSTEMS

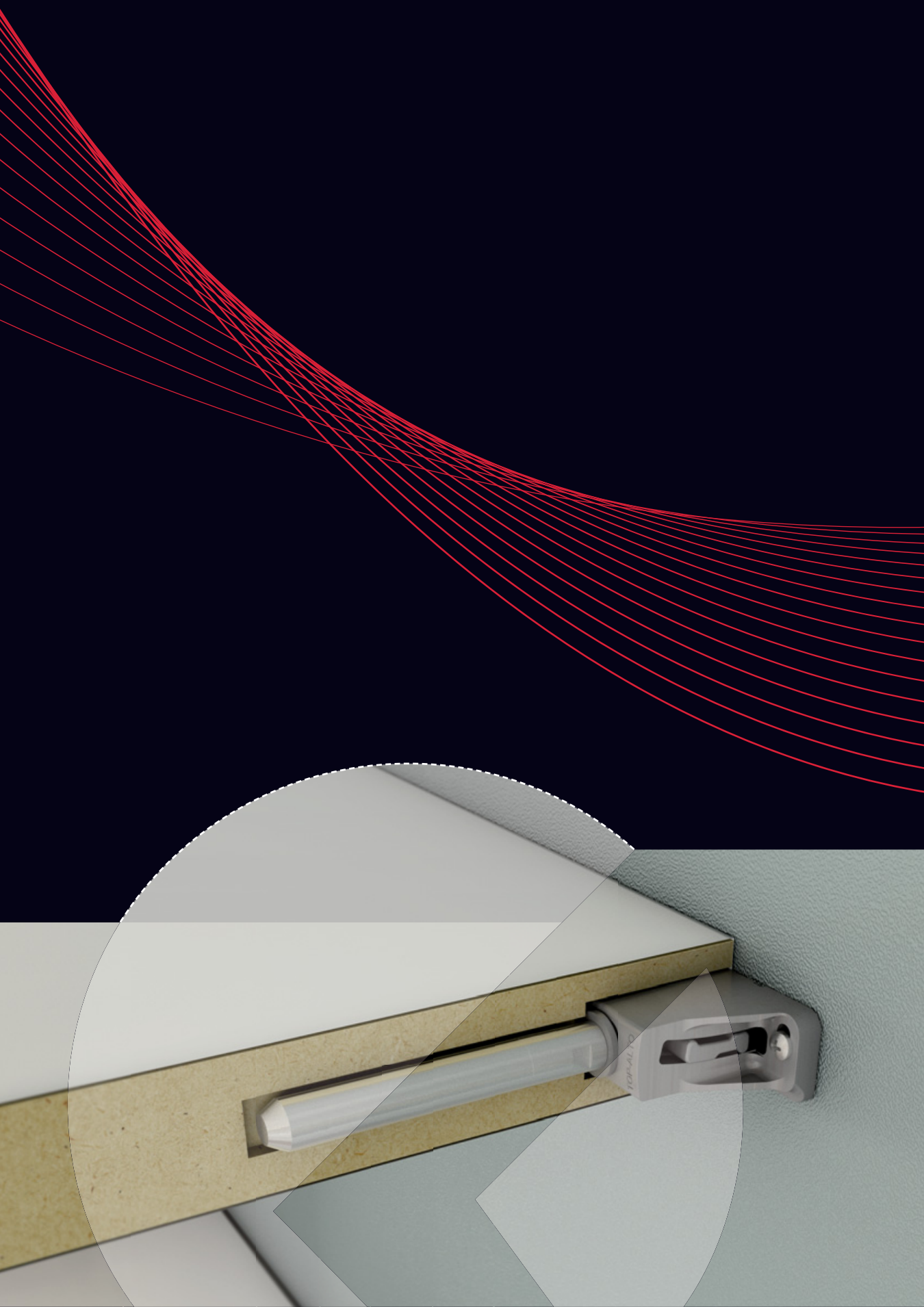



SYMBOLS AND FINISHES LEGEND

SYMBOLS

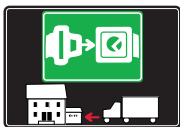

= SHELF SAFELY LOCKED DURING TRANSPORTATION AND AT HOME.



= ANTI-TURNOVER LOCKING SYSTEM



= NORMS / PATENTS



= PHILLIPS / POZIDRIV



= NEWTON



= PART.NO



= HEXAGONAL SOCKET



= FRICTION



= PCS. PER PACKAGE



= BLADE SLOT



= AUTOMATIC



= COMBI SLOT



= DROP DOWN



= CAPACITY LOADING



= COUNTERSUNK HEAD



= WOOD / GLASS THICKNESS



= PAN HEAD



= STANDARD HINGE



= HOLE DIAMETER



= FLANGE HEAD



= KIMANA HINGE



= DIAMETER



= FLAT HEAD



= FLAP HINGE



= LENGTH



= TRILOBULAR SCREW



= WITH SPRING



= HEIGHT



= SELF-TAPPING SCREW



= WITHOUT SPRING



= RIGHT VERSION



= EURO THREAD



= REVERSED SPRING



= LEFT VERSION



= METRIC THREAD



= SETTING CODE



= PRE-INSERTED SCREW



= FOR ROUND TUBE



= PCS. PER PAD



= PRE-INSERTED SCREW AND SPREADING BUSH



= FOR OVAL TUBE



= CUT ON REQUEST



= WITH BUFFER



= SELF ADHESIVE













= WITH MAGNET



= WITH FLANGE

NOTE: Printing errors and omissions may exist despite our best efforts to ensure accuracy. We reserve the right to alter specifications without notice.

MATERIALS









 ZA = Zinc Alloy	 ST = Steel	 HSS = High Speed Steel	 BR = Brass	 ABS = Acrylonitrile Butadiene Styrene
 ZAnk = Nickel-plated Zinc Alloy	 STzk = Zinc-plated Steel	 AL = Aluminium	 WD = Wood	 EVA = Ethylene Vinyl Acetate

 EP = **ENGINEERING PLASTIC**

+  EP = other engineering plastic available on request

 SR = **SOFT RUBBER**

+  SR = other soft rubber available on request

 EPn = Natural Engineering Plastic	 EPc = Clear Engineering Plastic	 SRn = Natural Soft Rubber
 EPw = White Engineering Plastic	 EPg = Grey Engineering Plastic	 SRw = White Soft Rubber
 EPwg = Water Green Engineering Plastic		 SRb = Black Soft Rubber

FINISHES

+  = OTHER FINISHES AVAILABLE ON REQUEST

PART. NO	FINISHES	PART. NO	FINISHES	PART. NO	FINISHES
AA	Natural	JB	Bright Aluminium	QB	Walnut
AB	White	JC	Aluminium - Chrome	RO	Red
AC	Opal White	JD	Matt Aluminium	UZ	T -Met
AE	White 9010	JE	Satin-finished Aluminium	WA	Bronzed
AK	Champagne	JF	Aluminium - Brass	WI	Burnished
AL	Ivory	JG	Aluminium 5	XD	Satin-finished Steel
EA	Black	JL	Aluminium PE 11	YA	Nickel-plated
EB	Glossy Black	JM	Aluminium RAL 9006	YB	Bright Nickel-plated
EC	Matt Black	KA	Chrome	YC	Matt Nickel-plated
EE	Anthracite	KB	Bright Chrome	YD	Satin-finished Nickel-plated
FU	Gunmetal	KC	Matt Chrome	ZA	Zinc alloy
GR	Raw	MA	Brown	ZN	Zinc-plated
HA	Brass-Plated	MB	Light Brown 1	ZQ	Bright Gold
HH	Tropicalized	NN	Metallic Beige	ZY	Titanium
HL	Raw Brass	NO	Beige	ZZ	Clear
IA	Grey	OA	Oak	00	Insignificant finish
IB	Metallic Grey	OZ	Ash		
IF	Middle Grey	PA	Light Ash		
IJ	Light Grey	PZ	Beech		
IL	Grey 20	QA	Maple		

TRIADE MAXI

TRIADE MAXI is the concealed mounting bracket for shelves minimum 40mm thick. It has been conceived to simplify the shelf installation. It is provided with three independent adjustments:

1) VERTICAL

Before installing the shelf, the mounting brackets can be adjusted in height and (vertically) aligned through the slots.

2) HORIZONTAL

While placing the shelf in position, the supporting pins can be slid horizontally.

3) INCLINATION

When the shelf is partially inserted, the shelf angle can be adjusted front to back by turning the supporting pins with a 12mm open-ended wrench.

The capacity loading is 20Kg each (shelf weight included) for a shelf max 400mm deep.

Shelf minimum depth: 200mm.

Zinc alloy and steel

40 mm min. 

20 kg for each shelf support
for shelf 400 mm deep 

PAT. PENDING 

INSTALLATION AND ADJUSTMENTS

WOOD PANEL

VERY IMPORTANT

SOLID AND PLASTERBOARD PANEL

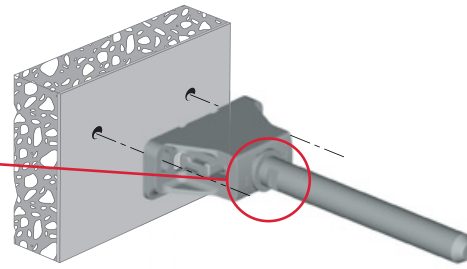
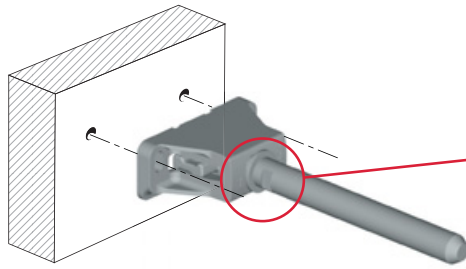

Recommended fixing pan head screw type - head Ø 5 mm max.

It is the responsibility of the customer:

- to ensure the wall is of a suitable quality to hold the shelf fixing in place.
- to use the proper hardware fittings according to the construction of the wall.

For more specific information, please refer to the WARNINGS section at the end of the catalogue.

BRACKET ALIGNMENT

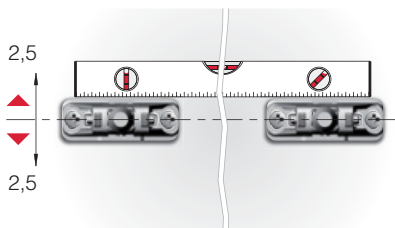

LATERAL ADJUSTMENT

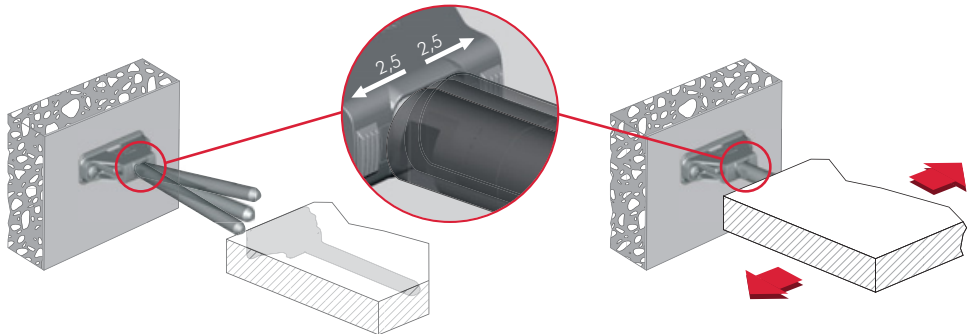

INCLINATION ADJUSTMENT

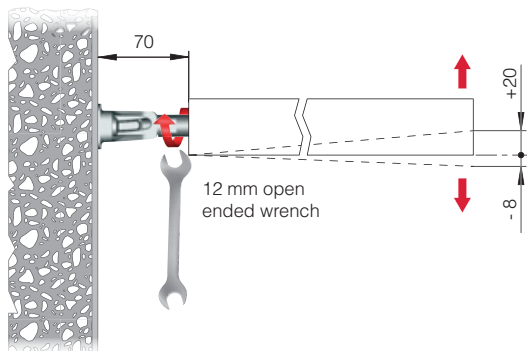

COMBINATION SHELF LOAD AND SHELF DEPTH

(The figures refer to 1 shelf support)

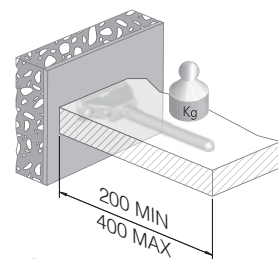
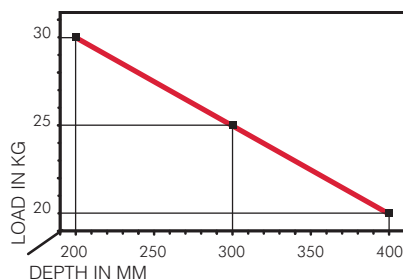

+ shelf weight = 20 kg MAX
for each shelf support

For installation details refer to "APPLICATION FOR ALL TRIADE VERSIONS"

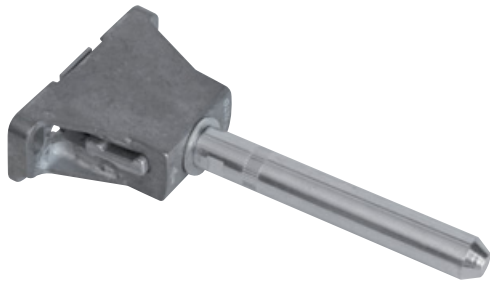

= PZ2 = open ended wrench 12 mm

 = 50 pcs.



1621601000

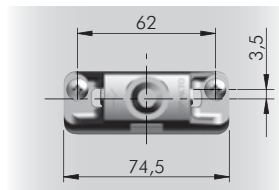
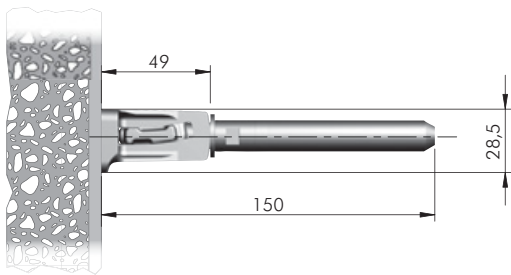

VERY IMPORTANT
Centre of the hole is shifted 3,5 mm upwards. Please keep in mind when levelling the shelf.

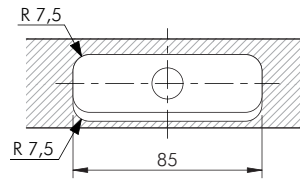
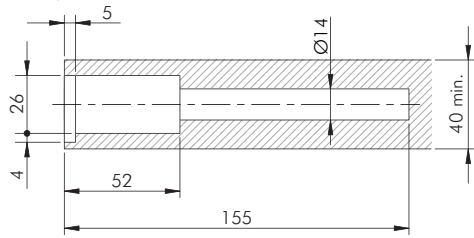

DRILL BIT FOR TRIADE MAXI

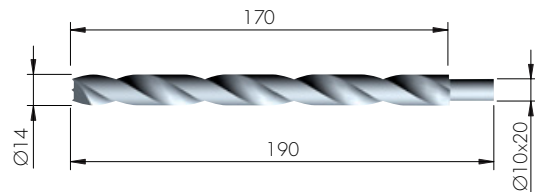
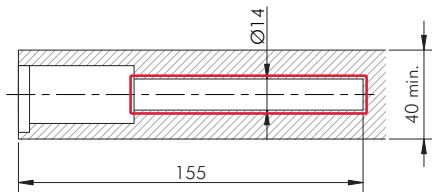

HSS = on request



1621452000

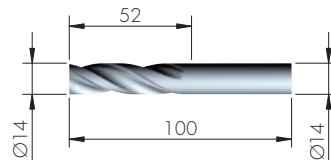
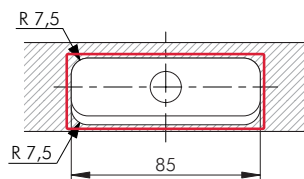
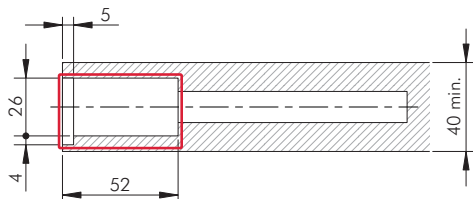

HSS = on request



1621454000

TRIADE MAXI AND BRACKET

INSTALLATION

SOLID AND PLASTERBOARD PANEL

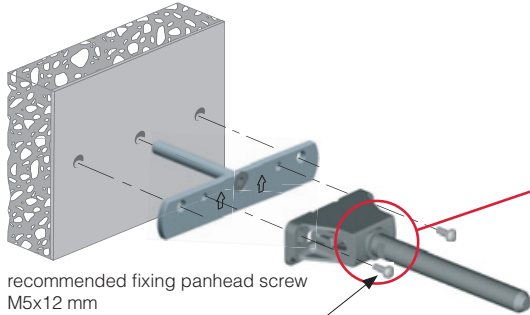

VERY IMPORTANT

Triade Maxi has to be installed with the arrow facing upwards.

It is the responsibility of the customer:

- to ensure the wall is of a suitable quality to hold the shelf fixing in place.
- to use the proper hardware fittings according to the construction of the wall.

For more specific information, please refer to the WARNINGS section at the end of the catalogue.

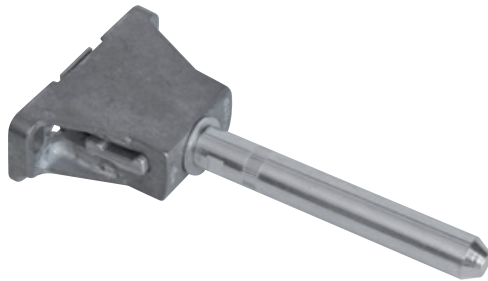

	= PZ2		= open ended wrench 12 mm
			= 50 pcs.
		1621601000	



	= M5			= 100 pcs.
			16215030ZN	

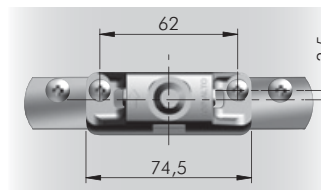
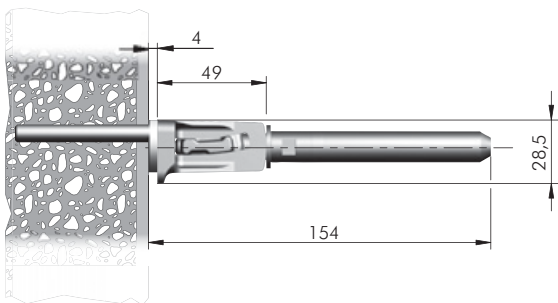

VERY IMPORTANT

Centre of the hole is shifted 3,5 mm upwards. Please keep in mind when levelling the shelf.

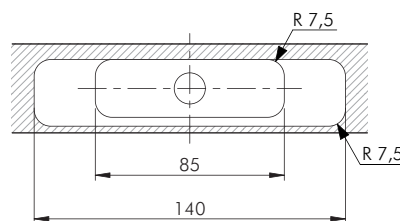
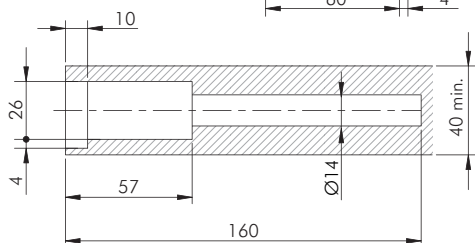
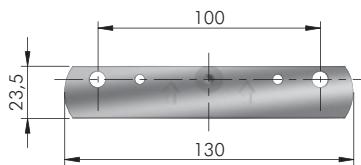
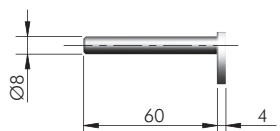



TRIADE MAXI BRACKET FIXING ACCESSORY



= M5	= PZ2	
ST		= 1000 pcs.
123 60334030ZN		

DRILL BIT FOR TRIADE MAXI AND BRACKET

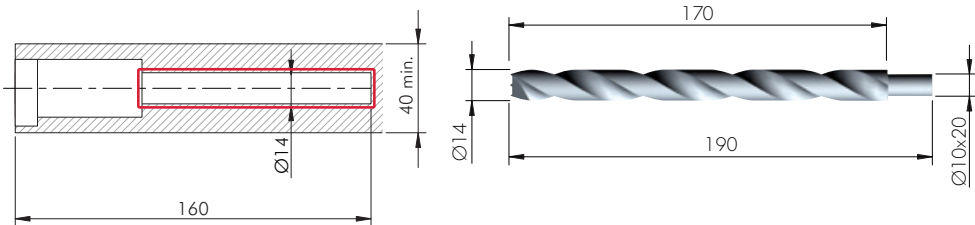

HSS	= on request
123 1621452000	

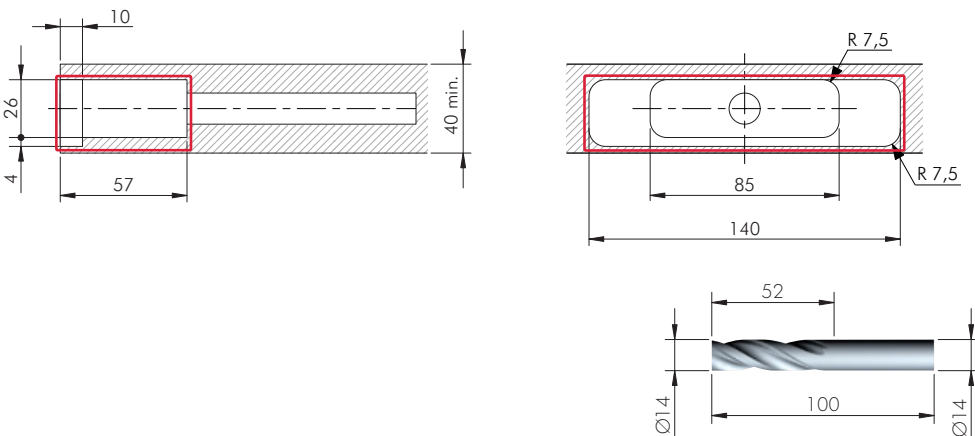

HSS	= on request
123 1621454000	

APPLICATION FOR ALL TRIADE VERSIONS

VERTICAL ADJUSTMENTS

RELEASE THE FIXING SCREWS

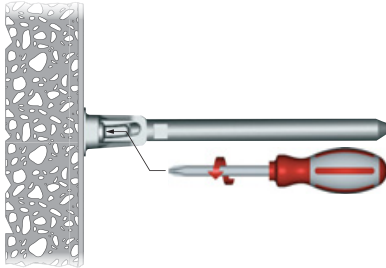

ALIGN BRACKETS VERTICALLY ACCORDINGLY

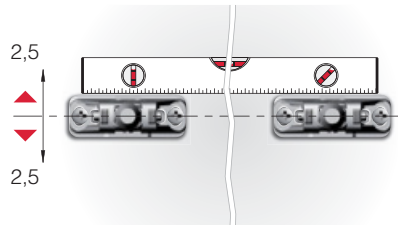

TIGHT THE FIXING SCREWS

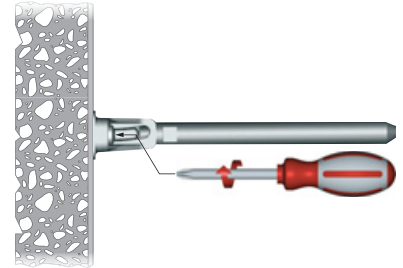

SHELF INSERTING AND LATERAL ADJUSTMENT

TILT THE SHELF TO MATCH BOTH SUPPORTING PINS AND SHELF HOUSINGS

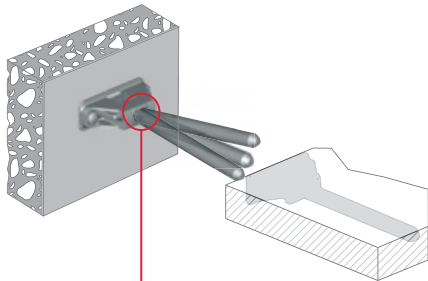

INSERT PARTIALLY THE SHELF

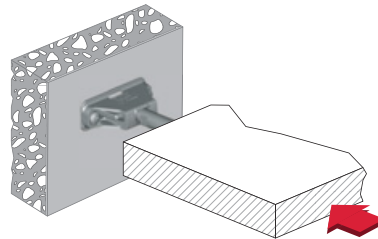

ADJUST THE SHELF LATERALLY ACCORDING TO THE APPLICATION (i.e. MULTI-SHELF COMPOSITION)

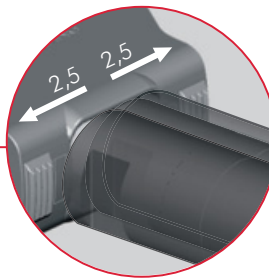
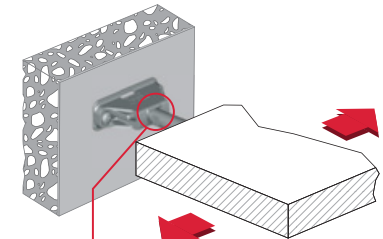

INCLINATION ADJUSTMENTS

TURN CLOCKWISE THE SUPPORTING PIN WITH A 10 - 12 mm OPEN-ENDED WRENCH TO ADJUST THE SHELF ANGLE FRONT TO BACK ACCORDINGLY

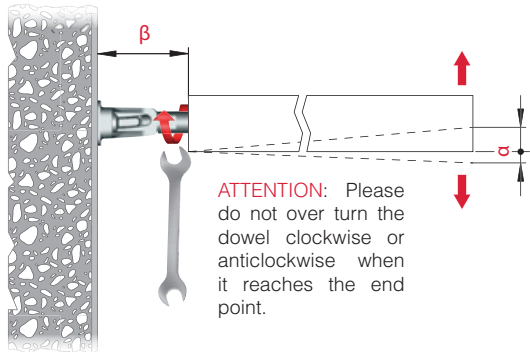

MODEL	β(mm)	α(mm)
TRIADE MINI	approx. 45	-6 +13
TRIADE	approx. 45	-6 +13
TRIADE MAXI	approx. 70	-8 +20
TRIADE XXL	approx. 70	-8 +20

SCREW THE LOCKING BOLT TO BLOCK THE PIN

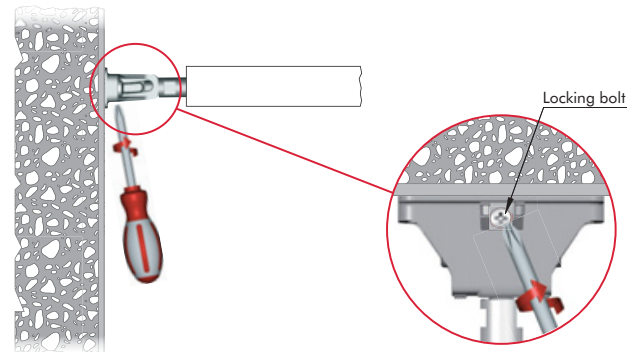

SHELF INSERTING FOR ALL TRIADE MODELS

PUSH THE SHELF AGAINST THE WALL UNTIL THE END

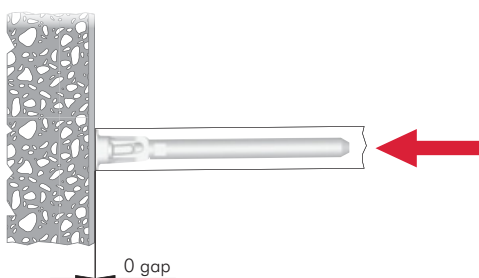

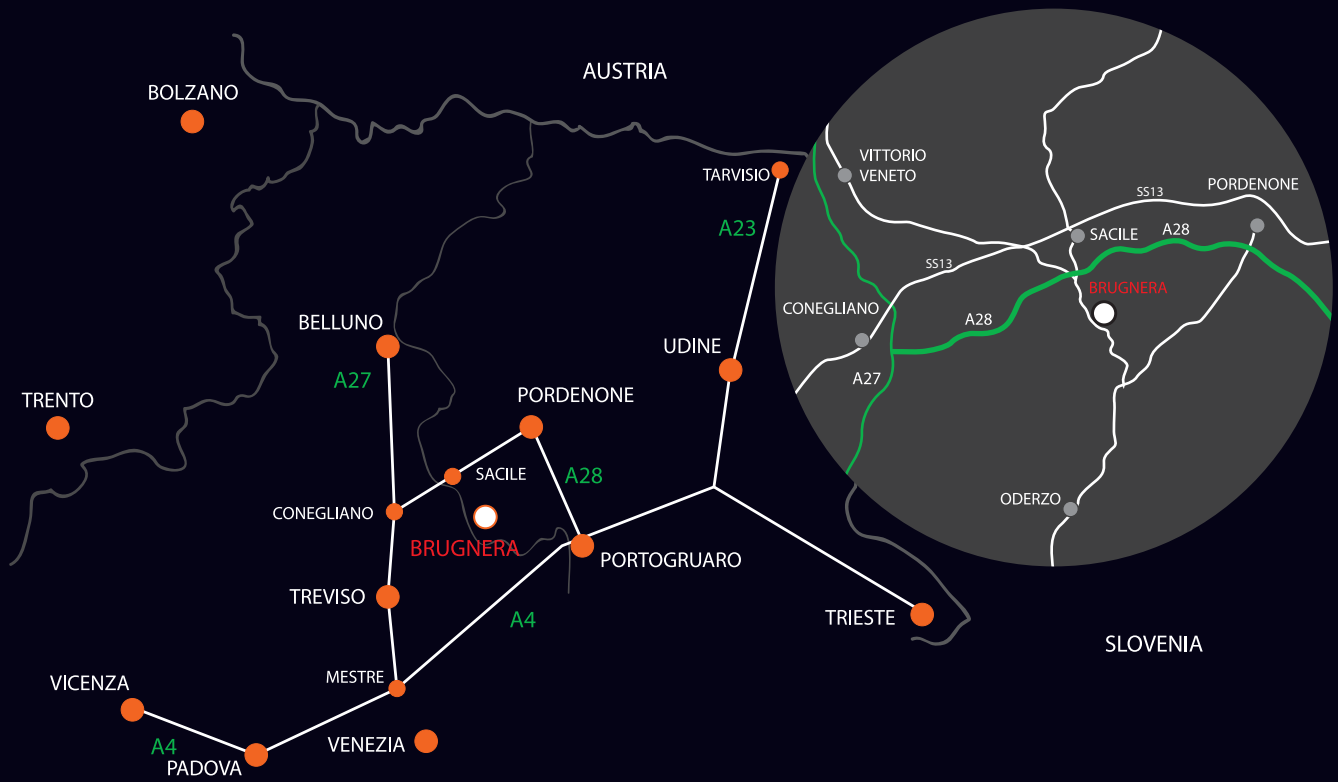

www.italianaferramenta.com