

TRIS SIDE BRACKET ROUND LEDGE



SHELF
SUPPORTS



SYMBOLS AND FINISHES LEGEND

SYMBOLS



= SHELF SAFELY LOCKED DURING TRANSPORTATION AND AT HOME.



= ANTI-TURNOVER LOCKING SYSTEM



= NORMS / PATENTS



= PHILLIPS / POZIDRIV



= NEWTON



= PART.NO



= HEXAGONAL SOCKET



= FRICTION



= PCS. PER PACKAGE



= BLADE SLOT



= AUTOMATIC



= COMBI SLOT



= DROP DOWN



= CAPACITY LOADING



= COUNTERSUNK HEAD



= WOOD / GLASS THICKNESS



= PAN HEAD



= STANDARD HINGE



= HOLE DIAMETER



= FLANGE HEAD



= KIMANA HINGE



= DIAMETER



= FLAT HEAD



= FLAP HINGE



= LENGTH



= TRILOBULAR SCREW



= WITH SPRING



= HEIGHT



= SELF-TAPPING SCREW



= WITHOUT SPRING



= RIGHT VERSION



= EURO THREAD



= REVERSED SPRING



= LEFT VERSION



= METRIC THREAD



= SETTING CODE



= PRE-INSERTED SCREW



= FOR ROUND TUBE



= PCS. PER PAD



= PRE-INSERTED SCREW AND SPREADING BUSH



= FOR OVAL TUBE



= CUT ON REQUEST



= WITH BUFFER



= SELF ADHESIVE



= WITH MAGNET



= WITH FLANGE

NOTE: Printing errors and omissions may exist despite our best efforts to ensure accuracy. We reserve the right to alter specifications without notice.

MATERIALS

ZA = Zinc Alloy

ST = Steel

HSS = High Speed Steel

BR = Brass

ABS = Acrylonitrile
Butadiene Styrene

ZAnk = Nickel-plated
Zinc Alloy

STzk = Zinc-plated Steel

AL = Aluminium

WD = Wood

EVA = Ethylene Vinyl
Acetate

EP = **ENGINEERING PLASTIC**

+ **EP** = other engineering plastic
available on request

SR = **SOFT RUBBER**

+ **SR** = other soft rubber
available on request

EPn = Natural Engineering Plastic

EPc = Clear Engineering Plastic

SRn = Natural Soft Rubber

EPw = White Engineering Plastic

EPg = Grey Engineering Plastic

SRw = White Soft Rubber

EPwg = Water Green Engineering Plastic

SRb = Black Soft Rubber



FINISHES



= OTHER FINISHES AVAILABLE
ON REQUEST

PART. NO	FINISHES	PART. NO	FINISHES	PART. NO	FINISHES
AA	Natural	JB	Bright Aluminium	QB	Walnut
AB	White	JC	Aluminium - Chrome	RO	Red
AC	Opal White	JD	Matt Aluminium	UZ	T -Met
AE	White 9010	JE	Satin-finished Aluminium	WA	Bronzed
AK	Champagne	JF	Aluminium - Brass	WI	Burnished
AL	Ivory	JG	Aluminium 5	XD	Satin-finished Steel
EA	Black	JL	Aluminium PE 11	YA	Nickel-plated
EB	Glossy Black	JM	Aluminium RAL 9006	YB	Bright Nickel-plated
EC	Matt Black	KA	Chrome	YC	Matt Nickel-plated
EE	Anthracite	KB	Bright Chrome	YD	Satin-finished Nickel-plated
FU	Gunmetal	KC	Matt Chrome	ZA	Zinc alloy
GR	Raw	MA	Brown	ZN	Zinc-plated
HA	Brass-Plated	MB	Light Brown 1	ZQ	Bright Gold
HH	Tropicalized	NN	Metallic Beige	ZY	Titanium
HL	Raw Brass	NO	Beige	ZZ	Clear
IA	Grey	OA	Oak	00	Insignificant finish
IB	Metallic Grey	OZ	Ash		
IF	Middle Grey	PA	Light Ash		
IJ	Light Grey	PZ	Beech		
IL	Grey 20	QA	Maple		



TRIS FOR 35 mm SHELF MIN. SIDE BRACKET ROUND LEDGE

TRIS is the shelf support slotted into the shelf by making edge borings. If required the side bracket ledge can flush with the underside of the shelf by making face borings. The sleeve of the shelf support can be expanded by inserting a pin (pin=optional extra), which improves the structural fastening of the shelf to the sides of the furniture. The shelf has to be pushed downwards onto the side brackets, which can be screwed into any position required. The side brackets slot into the socket of the shelf supports and a click locks the shelf in position.

The TRIS ROUND LEDGE brackets are available in 3 different versions: with spreading bush and screw pre-inserted only for 30 mm shelf thickness version, and with hole for screw fixing, with pin \varnothing 5 only for 25 mm shelf thickness version.

TRIS ROUND LEDGE is available for 25(29), 30(34) mm shelf thickness.

35 mm min.

UNI EN 14749/05

INSTALLATION AND ASSEMBLING

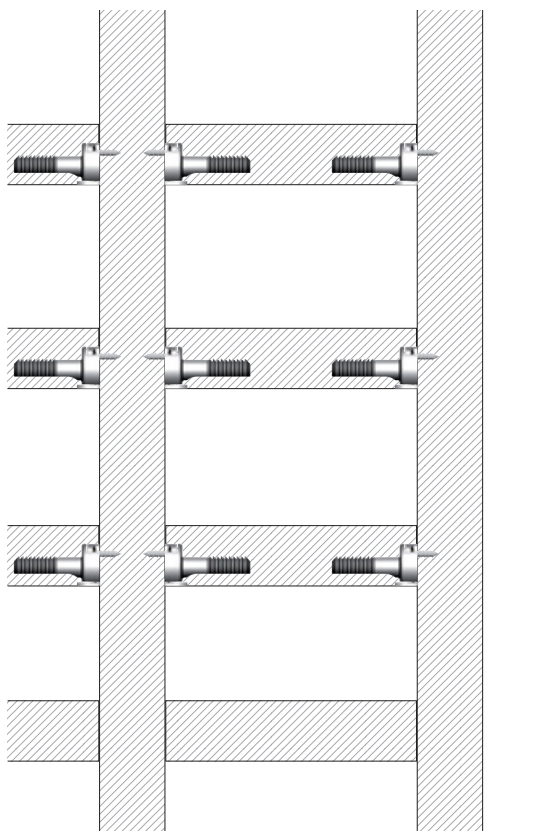
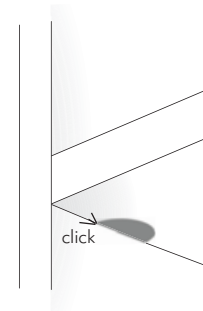
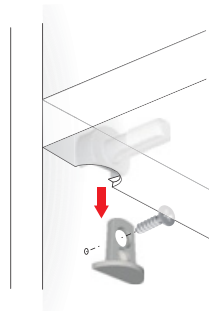
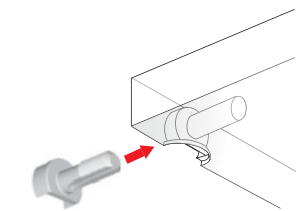

Assembling with alternative fixing options.

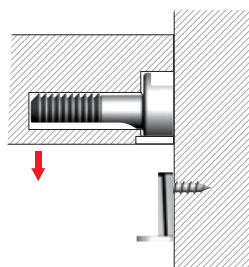

Assembling with pre-inserted spreading bush and screw to avoid hole damaging for shelf repositioning.

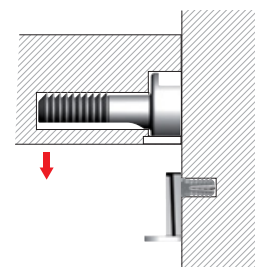

OPTIONAL FIXING:

to achieve much more horizontal connection fixing. The sleeve expands by inserting the provided \varnothing 3 mm pin.

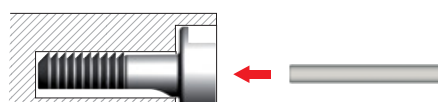

Also suitable for top and bottom panels when a back panel is used.

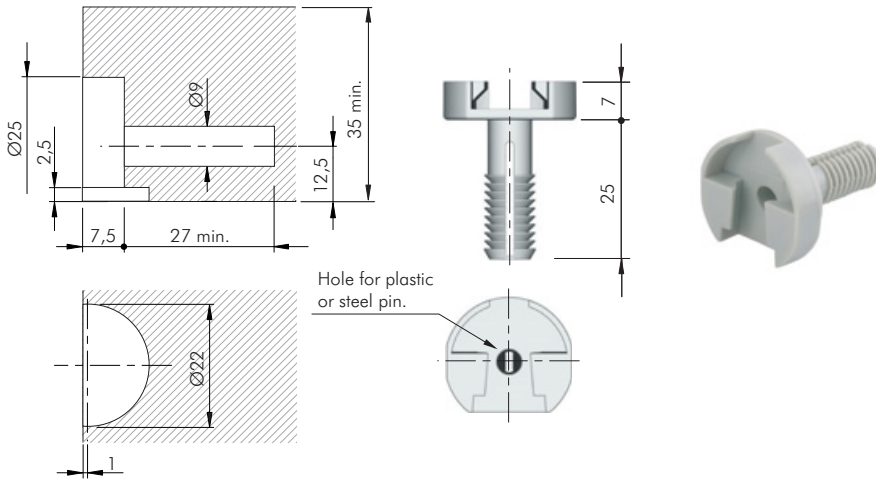

EP	= 4000 pcs.
123	
10901020AB	

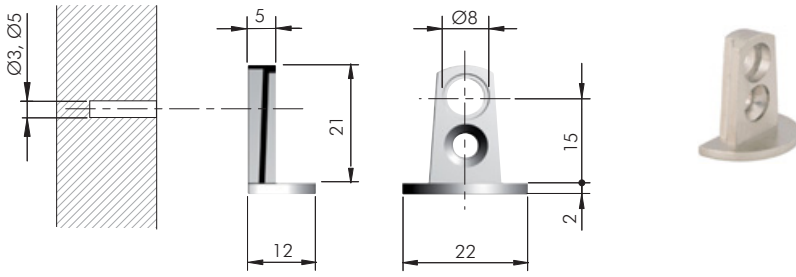

= Ø 3, Ø 5 mm	
ZA	= 3000 pcs.
123	
10907110YA	

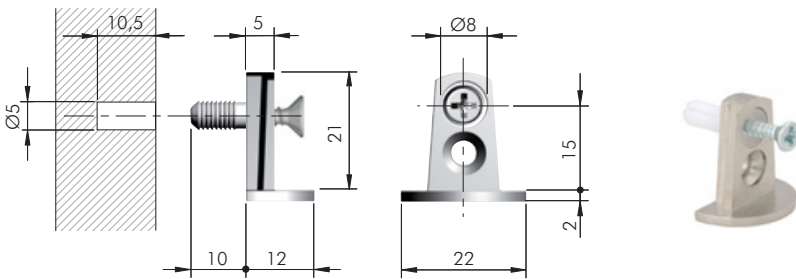

= Ø 5 mm	
= PZ2	
ZA ST EP	= 3000 pcs.
123	
10907120YA	

DRILL BIT FOR TRIS ROUND LEDGE 35 mm

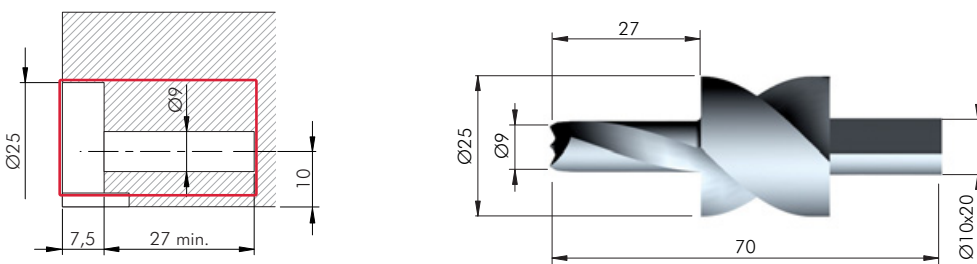

HSS	= on request
123	
1090207000	
1090208000	



SHELF
SUPPORTS

TRIS SIDE BRACKET ROUND LEDGE

ITALIANA
ferramenta

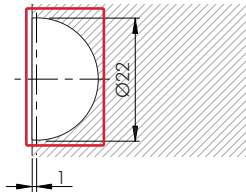
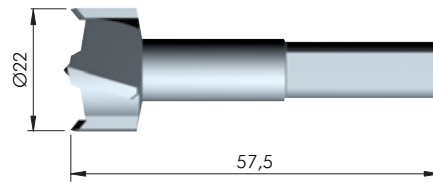
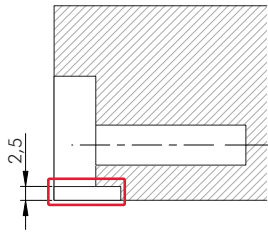

HSS	= on request
1090210000	

TRIS FIXING ACCESSORIES

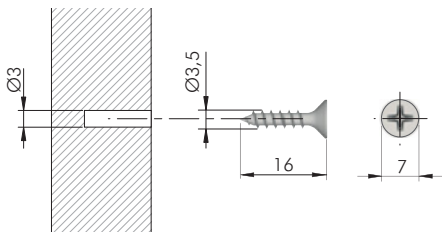

= Ø 3 mm	
= PZ2	
ST	= 10.000 pcs.
60101390ZN	

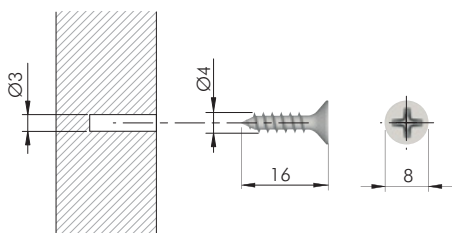

= Ø 3 mm	
= PZ2	
ST	= 5000 pcs.
60101570ZN	

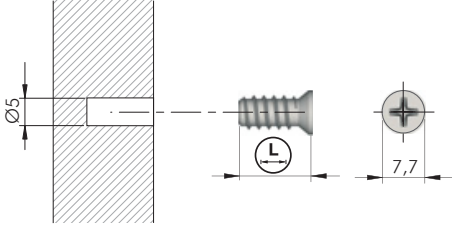

= Ø 5 mm +

= PZ2

ST

60502010Z N	10	9000
60501050Y A	12,7	5000
60502020Z N	13	5000
60502030Z N	15	5000

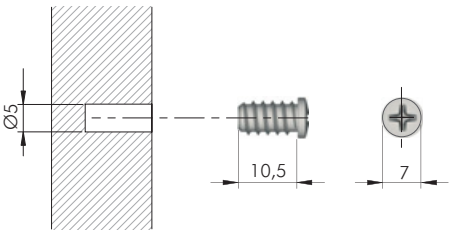

= Ø 5 mm +

= PZ2

ST

= 5000 pcs.

60507010Y A

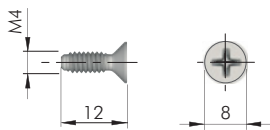

= M4 = PZ2

ST

= 2000 pcs.

60305040Z N

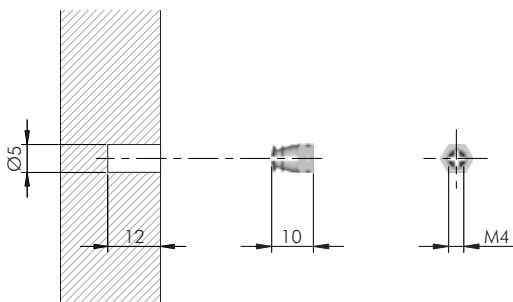

= Ø 5 mm = M4

BR

= 20.000 pcs.

20502021H L

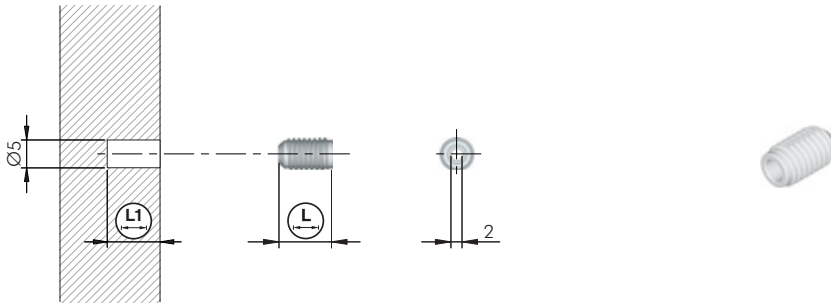

= Ø 5 mm

= 5000 pcs.

123		
20302020AA	9,5	11,5
20302030AA	13	15

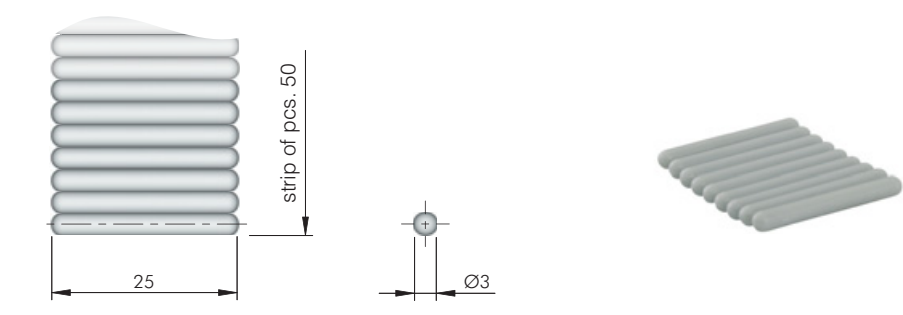

= 50.000 pcs.

123	
10950010AB	
10950010EA	

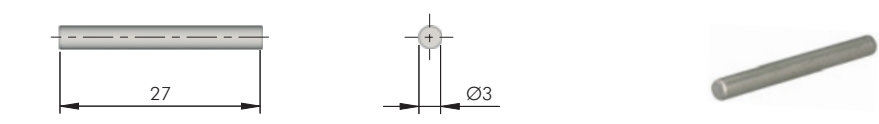

= 15.000 pcs.

123	
10951010ZN	

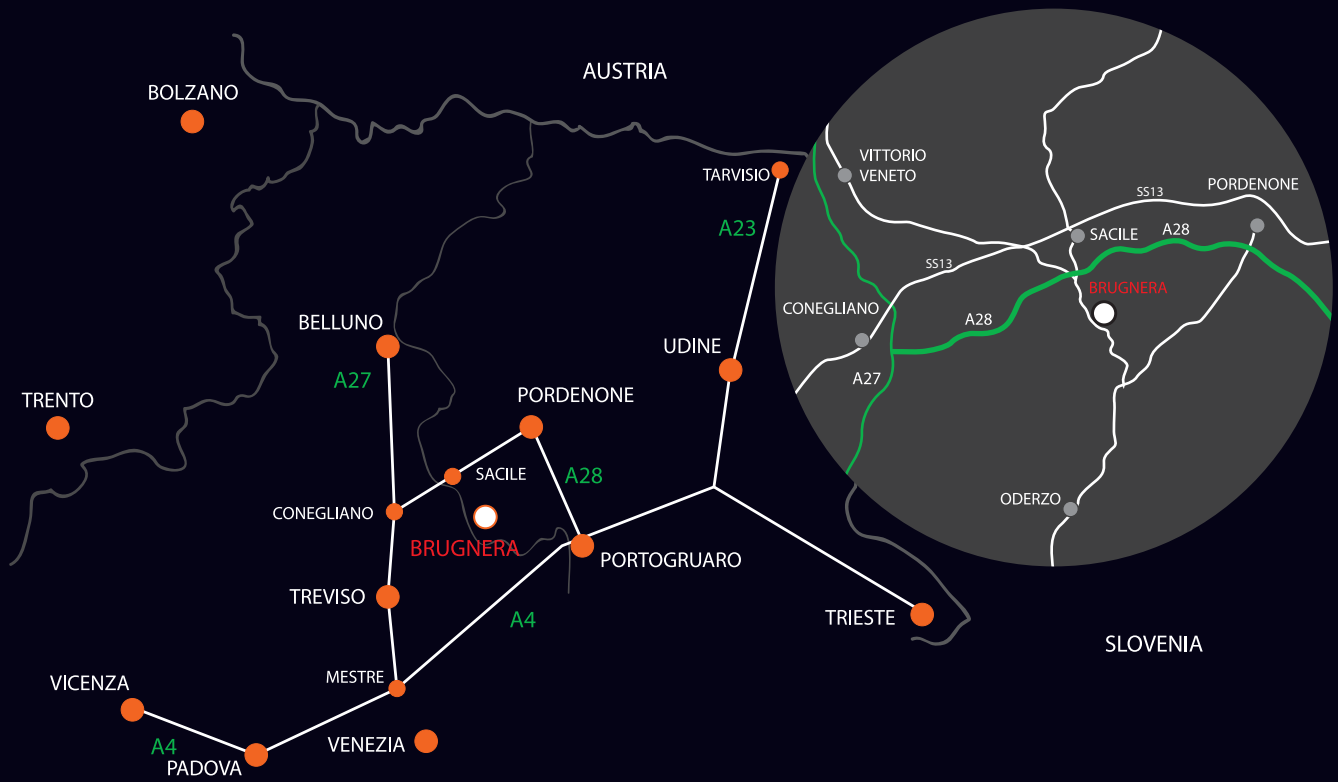

www.italianaferramenta.com